

D

GB

F

I

ES

PL



Toll Box Europe

Sittraffic Sensus Unit C3080
Installationsanleitung/Quick Start Guide/
Guide de prise en main/Instrucciones de
instalación/Инструкция по установке/
Instrucciones de instalación/Skrócona
instrukcja/Instrucțiuni de instalare

Toll4Europe:
www.toll4europe.eu

 **TOLL 4 EUROPE**

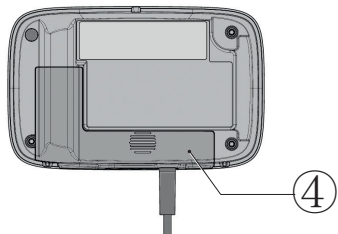
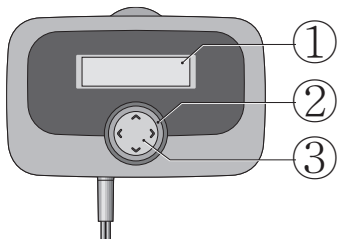

Technical Data OBU C3080

(A)	Operation: -40°...+85 °C (with limited GSM functionality) -30°...<+70 °C (full functionality) Storage: -40°...+85 °C
(B)	8...32 V DC
(C)	Standby typical: ≤ 55 mA at 24 V DC Normal operation: 819 mA at 24 V DC Current consumption: ≤ 1 A
(D)	GNSS/GPS receiver module with internal antenna
(E)	GSM module with internal antenna
(F)	Microwave DSRC EETS standard with internal antenna
(G)	Lithium-Ion battery 3,6 V DC, 2100 mAh (satisfies UN transport test 38.3)
(H)	IP54 acc. IEC 60529
(I)	260 g
(J)	145 x 93 x 36 mm
(1)	Display
(2)	Status indication
(3)	Four direction navigation button
(4)	Rear: battery compartment

(A) – (J) / (1) – (4) Please find detailed explanation on rear page.

Siemens AG, RC-DE
Otto-Hahn-Ring 6
81739 Munich
Germany



© 06.2021

C97158-C3080-C138-04-1Q

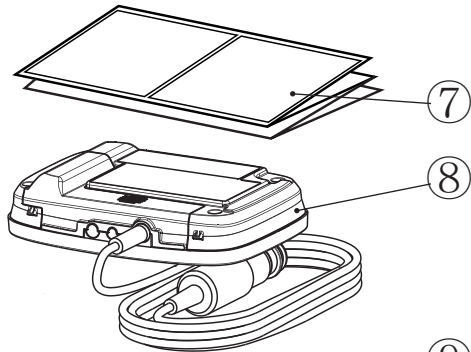
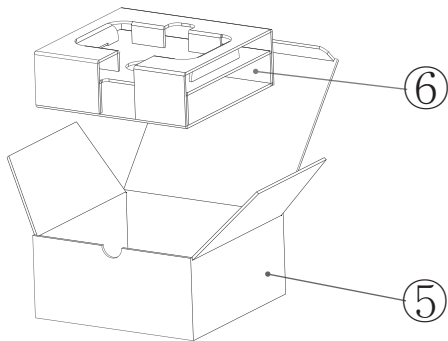

⑤	Box
⑥	Inlay
⑦	Quick start guide
⑧	OBU C3080 with cable
⑨	Cleaning cloth
⑩	Holder with adhesive pads

Please check if the package content is complete and undamaged.

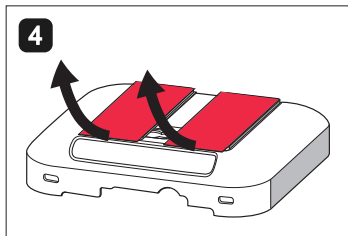
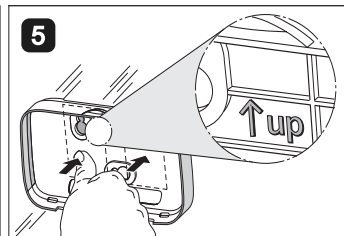
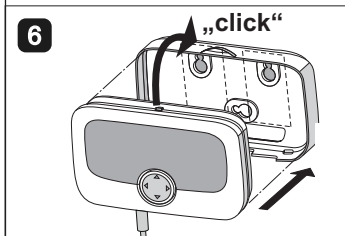
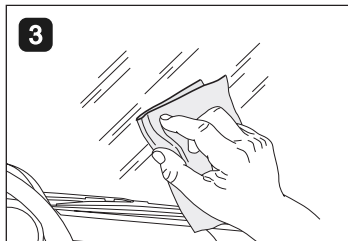
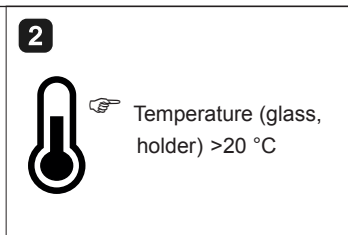
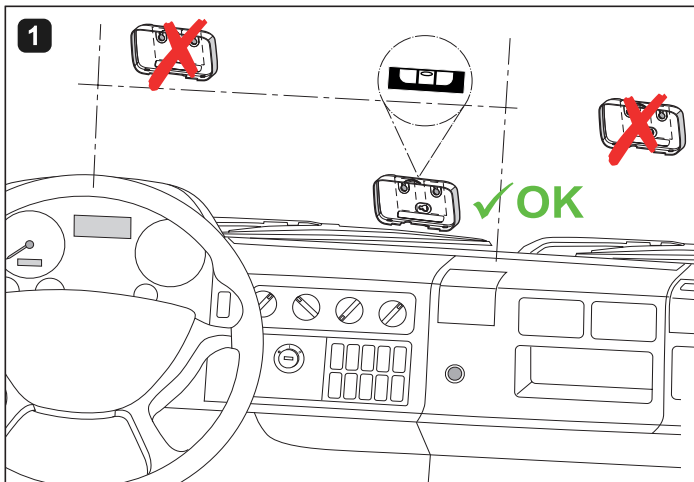

1 ... for cigarette lighter socket

2 ... for DIN standard socket

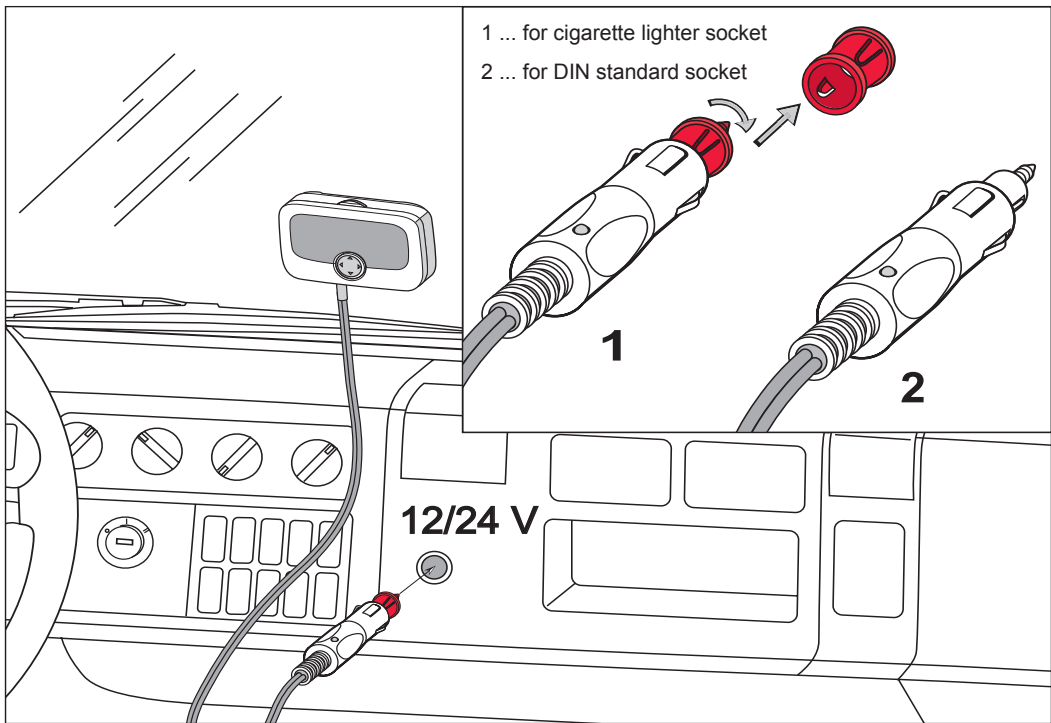

Usage with flexible power connection

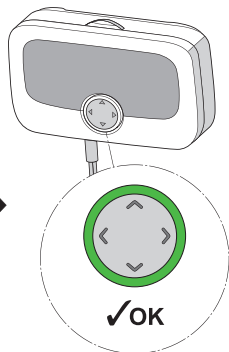
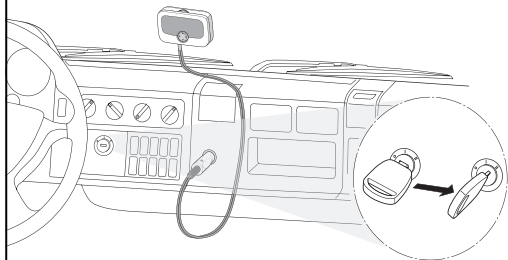

Usage with permanent power connection

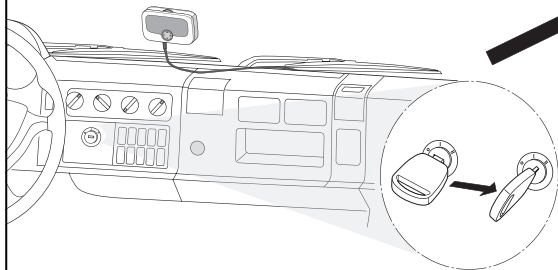

As soon as you start the vehicle, the OBU is switched on automatically.

For a permanent power connection please contact a qualified garage for installation.

Information for fixed installation by a professional workshop

Vehicle electrical system

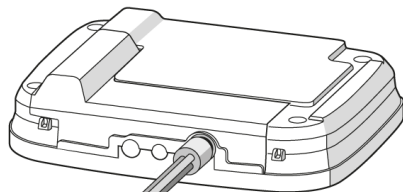
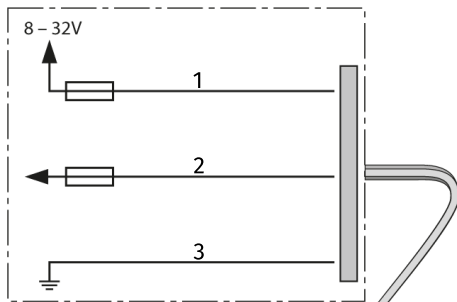

Permanent power supply cable

1. Red: constant voltage (+)
 2. Black: ignition
 3. Brown: ground (-)
- *Fuses (2A) not included



GREEN

EETS Service is activated for this toll domain.
You can continue to drive.



YELLOW

EETS Service is either

- **> not activated > not available or > not mandatory:** check message on OBU. In case of obligation to pay toll, use tolling equipment of local toll provider.



RED









































































- Technical failure. **OBU not ok.**

1. Stop driving and exit road.
2. Check message on OBU display.
3. Call your customer support.

- If no GPS for more than 30 minutes

1. If you are e.g. in a garage, drive to a place with GPS reception.
2. If the problem persists, call your customer support.



Toll Service	OBU start display	Toll Service	OBU start display
DE – Germany 	 DEbag ≥ 7.5  3  LPN1234  5 	CH – Switzerland 	 CHsv ≥ 11.8  3  LPN1234  5 
DE – German tunnels 	 DETun $\geq -$  -  LPN1234  - 	ES – Spain 	 ESvia $\geq -$  3  LPN1234  - 
BE – Belgium 	 BEvia ≥ 11.8  -  LPN1234  5 	FR – France 	 FRtis ≥ 60.0  3  LPN1234  5 
BE – Liefkenshoek tunnel 	 BELit $\geq -$  -  LPN1234  - 	HU – Hungary 	 HUgo $\geq -$  3  LPN1234  - 
AT – Austria 	 ATasf $\geq -$  3  LPN1234  5 	IT – Italy 	 ITsit ≥ 7.5  3  LPN1234  5 
BG – Bulgaria 	 BGria ≥ 11.8  3  LPN1234  5 	PT – Portugal 	 PTvve $\geq -$  3  LPN1234  - 

Status 2021: More services to follow.

OBU parameter settings

Driver must entry correct values via OBU and control the setting on the OBU display

Toll Service	Trailer axles	Truck weight	Trailer weight	OBU beep*
DE	x	x		
BE/tunnels				
AT	x			x
CH	x		x	
BG/FR/HU/IT/(ES/PT)	x			

Editable values

OBU Main Menu
Language
Axles trailer >
Weight DEbag (Germany: DE-BAG) >
Configuration CHlsv (Switzerland: CH-LSV) >
Toll services
Value added service
Global parameters
OBU information
Customer Service

Axles trailer:

Weight DEbag (Germany: DE-BAG):

< 7,5t
≥ 7,5t < 12t
≥ 12t ≤ 18t
< 18t

Configuration CHlsv (Switzerland: CH-LSV)

Configuration CHlsv Trailer weight	Trailer weight 12,34t
Configuration CHlsv Transport mode	on off

*Each successful transaction is reflected by one buzzer of the OBU when passing a toll station

D

Sicherheitshinweise:



Nutzung in explosionsgefährdeten Räumen:

Eine Nutzung des Gerätes in explosionsgefährdeten Räumen ist entsprechend EU Richtlinie 2014/53/EU nicht erlaubt. Bei Nutzung in explosionsgefährdeten Räumen sind die Anweisungen der Bedienungsanleitung zu befolgen.



Gefahr durch Akku:

Akku vor mechanischer Belastung (Stöße, Stürze, Vibrationen) bzw. Temperaturen über 85 °C schützen! Brandgefahr! Weitere Schutzmaßnahmen und Verhaltensregeln sind den Anweisungen in der Bedienungsanleitung zu entnehmen.



Gefahr durch Sichtbehinderung:

Montieren Sie die OBU immer so an der Frontscheibe, dass das Sichtfeld des Fahrers nicht beeinträchtigt wird. Bei Fragen kontaktieren Sie bitte den Kundendienst.



Gefahr während der Fahrt:

Eine Bedienung der OBU während der Fahrt ist nicht zulässig. Die Navigationstaste ist gesperrt, um eine Bedienung während der Fahrt auszuschließen.



Allgemeine Hinweise:

Bedienen Sie die OBU nicht mit spitzen oder scharfen Gegenständen. Verwenden Sie zur Reinigung nur ein leicht angefeuchtetes Tuch, keinesfalls Scheuer- oder Lösungsmittel. Ein beschädigtes Spannungsversorgungskabel bitte sofort ersetzen – Kurzschlussgefahr!



Hinweise zur Befestigung:

Der Befestigungsbereich der Frontscheibe muss sauber, trocken, fett- und öl-frei sein. Das Anbringen der Halterung an der Windschutzscheibe muss bei Temperaturen über +20 °C erfolgen. Wenn nötig, bringen Sie Scheibe und Halterung erst auf eine geeignete Temperatur. Der Klebstoff ist bei Temperaturen über +20 °C 72 Stunden nach Anwendung vollständig ausgehärtet.

Hinweise zur Montage und Inbetriebnahme:

Die Sitraffic Sensus Unit C3080 (OBU) ist ein wiederverwendbares Gerät, welches leicht zu installieren ist. Die Erstinbetriebnahme läuft automatisch ab.

Weitere Sicherheitshinweise und eine ausführliche Bedienungsanleitung können bezogen werden unter: www.toll4europe.eu

Kundendienst:

Wenden Sie sich bitte bei Fragen zu Ihrer OBU an Ihren Vertriebspartner.



Entsorgen Sie dieses Produkt keinesfalls über den Hausmüll!
Rückgabe siehe unter: www.toll4europe.eu

CE Kennzeichnung und Konformitätserklärung:

Die OBU stimmt mit den Vorgaben folgender Richtlinien überein:

2014/53/EU	RICHTLINIE 2014/53/EU DES EUROPÄISCHEN PARLAMENTS UND DES RATES vom 16. April 2014 über die Harmonisierung der Rechtsvorschriften der Mitgliedstaaten über die Bereitstellung von Funkanlagen auf dem Markt und zur Aufhebung der Richtlinie 1999/5/EG
2011/65/EC	RICHTLINIE 2011/65/EU DES EUROPÄISCHEN PARLAMENTS UND DES RATES vom 8. Juni 2011 zur Beschränkung der Verwendung bestimmter gefährlicher Stoffe in Elektro- und Elektronikgeräten
2009/750/EG Annex III/2.1.2	ENTSCHEIDUNG DER KOMMISSION vom 6. Oktober 2009 über die Festlegung der Merkmale des europäischen elektronischen Mautdienstes und seiner technischen Komponenten; Anhang III/2.1.2

Die Konformitätserklärung kann bezogen werden unter:
www.siemens.com/mobility-sensusunit-certificates **Sitraffic Sensus Unit C3080**

In diesem Produkt wird Open Source Software eingesetzt.

Weitere Informationen dazu finden Sie unter:
www.siemens.com/mobility-sensusunit-certificates **License terms**

Erklärungen:

Vorderseite: ① Anzeige, ② Status-Anzeige, ③ Navigationstaste mit vier Richtungen
Rückseite: ④ Batteriefach

Lieferumfang:

⑤ Karton, ⑥ Einlage, ⑦ Installationsanleitung, ⑧ OBU C3080 mit Kabel, ⑨ Reinigungstuch, ⑩ Halter mit Klebepads

Technische Daten:

Ⓐ Temperatur, Ⓑ Spannung, Ⓒ Stromaufnahme, Ⓓ GNSS intern, Ⓔ GSM intern,
Ⓕ DSRC intern, Ⓖ Batterie, Ⓗ Schutzart, ① Gewicht (ohne Halterung), ② Abmessungen (ohne Halterung)

Technische Daten zur Verfügung gestellt von:

Siemens AG, RC-DE
Otto-Hahn-Ring 6
81739 Munich
Germany

Notes on safety:

**Usage in potential explosive atmosphere:**

According EU Directives 2014/53/EU, usage of OBU in potential explosive atmosphere in general is not permitted. For usage in potential explosive atmosphere please comply with procedure described in detailed instruction manual.

**Danger caused by (rechargeable) battery:**

Protect battery from mechanical strain (shock, drop, vibration) as well as temperatures $>+85\text{ }^{\circ}\text{C}$! Fire hazard! For further safety precautions and directives please follow detailed instruction manual.

**Danger of obstructed line-of-sight:**

Always mount the OBU in such a way that driver's field of vision is not impaired! If in doubt, please contact Customer Service.

**Risk of accident:**

Handling of the OBU while driving is not permitted! The navigation button is locked to prevent any operation during vehicle movement.

**General instructions:**

Do not operate the OBU with pointed or sharp-edged objects.
For cleaning use only a damp cloth, no solvents or abrasive cleaners. Replace damaged power supply cables immediately – danger of fire by short circuit!

**Hints for mounting:**

In the OBU fixing area the windscreen must be clean, dry and free from grease or oil. Mounting the holder to the windscreen has to be done at temperature above $+20\text{ }^{\circ}\text{C}$. If necessary, please bring windscreen and holder to appropriate temperature. At temperature $> +20\text{ }^{\circ}\text{C}$, the glue of the adhesive pads reaches its final strength 72h after application.

Instructions for installation and commissioning:

The Sitraffic Sensus Unit C3080 (OBU) is an easy-to-install, reusable device. Initial set-up is carried out automatically.

Further safety notes and a detailed instruction manual can be obtained at: www.toll4europe.eu

Customer support:

If you have any queries about your OBU, please get in touch with your sales partner.



Never dispose of this product in household garbage!

To return the product, please refer to: www.toll4europe.eu

CE Marking and Declaration of Conformity:

The OBU complies with the provisions of the following directives and regulations:

2014/53/EU	DIRECTIVE 2014/53/EU OF THE EUROPEAN PARLIAMENT AND OF THE COUNCIL of 16 April 2014 on the harmonisation of the laws of the Member States relating to the making available on the market of radio equipment and repealing Directive 1999/5/EC
2011/65/EC	DIRECTIVE 2011/65/EU OF THE EUROPEAN PARLIAMENT AND OF THE COUNCIL of 8 June 2011 on the restriction of the use of certain hazardous substances in electrical and electronic equipment
2009/750/EG Annex III/2.1.2	COMMISSION DECISION of 6 October 2009 on the definition of the European Electronic Toll Service and its technical elements; Annex III/2.1.2

The Declaration of Conformity can be obtained from web page:

www.siemens.com/mobility-sensusunit-certificates **Sitraffic Sensus Unit C3080**

This product uses open source software.

Further information on this subject can be obtained from web page:

www.siemens.com/mobility-sensusunit-certificates **License terms**

Explanations:

Front: ① display, ② status-indication, ③ four direction navigation button
Rear: ④ battery compartment

Package content: ⑤ box, ⑥ inlay, ⑦ quick start guide, ⑧ OBU C3080 with cable, ⑨ cleaning cloth, ⑩ holder with adhesive pads

Technical Data:

Ⓐ temperature, Ⓑ voltage, Ⓒ current consumption, Ⓓ internal GNSS,
Ⓔ internal GSM, Ⓕ internal DSRC, Ⓖ battery, Ⓗ protection class, Ⓘ weight (without holder), Ⓢ dimensions (without holder)

Technical data made available by:

Siemens AG, RC-DE
Otto-Hahn-Ring 6
81739 Munich
Germany

F

Consignes de sécurité :



Utilisation dans des locaux à risque d'explosion :

Conformément à la directive 2014/53/UE, il est interdit d'utiliser l'appareil dans des locaux à risque d'explosion. En cas d'utilisation dans des locaux à risque d'explosion, suivre les instructions du mode d'emploi détaillé.



Risque dû à la pile (rechargeable) :

Mettre la pile à l'abri de sollicitations mécaniques (chocs, chutes, vibrations) et de températures excédant 85 °C ! Risque d'incendie ! Pour plus de amples précautions d'emploi et consignes de sécurité, reportez-vous au mode d'emploi détaillé.



Risque dû à une visibilité entravée :

Monter l'OBU sur le pare-brise de manière à ce qu'il ne gêne pas le champ de vision du conducteur. Pour toute question, contacter le Service Après-Vente.



Risque pendant la conduite :

Il est interdit de manipuler l'OBU pendant la conduite. La touche de navigation est bloquée, afin d'exclure toute tentative de commande pendant la conduite.



Consignes générales :

Ne pas interférer avec l'OBU avec des objets pointus ou acérés. Pour le nettoyage, utiliser exclusivement un chiffon légèrement humide, en aucun cas des produits abrasifs ou à base de solvant. Remplacer immédiatement tout câble d'alimentation endommagé - risque d'incendie par court-circuit !



Consignes pour la fixation :

La zone de fixation sur le pare-brise doit être propre, sèche, exempte de graisse et d'huile. La pose du support sur le pare-brise doit s'effectuer à une température supérieure à +20 °C. Si nécessaire, mettre préalablement le pare-brise et le support la température appropriée. À des températures supérieures à +20 °C, la colle durcit intégralement 72 heures après son application.

Consignes l'installation et de mise en service :

Le Sitraffic Sensus Unit C3080 (OBU = unité embarquée) est un appareil réutilisable et facile à installer. La première mise en service se déroule automatiquement.

Vous trouverez de plus amples instructions de sécurité et une notice d'utilisation détaillée sous www.toll4europe.eu

Service client :

En cas de questions sur votre OBU, veuillez vous adresser à votre partenaire commercial.



Ne jetez en aucun cas cet appareil avec les déchets ménagers !

Voyez comment procéder à son retour sous : www.toll4europe.eu

Marquage CE et déclaration de conformité :

L'OBU satisfait aux consignes des directives suivantes :

2014/53/EU	DIRECTIVE 2014/53/UE DU PARLEMENT EUROPÉEN ET DU CONSEIL du 16 avril 2014 relative à l'harmonisation des législations des États membres concernant la mise à disposition sur le marché d'équipements radioélectriques et abrogeant la directive 1999/5/CE
2011/65/EC	DIRECTIVE 2011/65/UE DU PARLEMENT EUROPÉEN ET DU CONSEIL du 8 juin 2011 relative à la limitation de l'utilisation de certaines substances dangereuses dans les équipements électriques et électroniques
2009/750/EG Annexe III/2.1.2	DÉCISION DE LA COMMISSION du 6 octobre 2009 relative à la définition du service européen de télépéage et à ses aspects techniques, annexe III / 2.1.2

Il est possible de se procurer la déclaration de conformité à l'adresse : www.siemens.com/mobility-sensusunit-certificates **Sitraffic Sensus Unit C3080**

Ce produit utilise des logiciels libres.

De plus amples informations à ce sujet sont disponibles à l'adresse : www.siemens.com/mobility-sensusunit-certificates **License terms**

Description :

Partie avant : ① affichage, ② indication d'état, ③ touche de navigation directionnelle
Partie arrière : ④ compartiment de pile

Contenu de la boîte :

⑤ Carton, ⑥ Insert, ⑦ Notice d'installation, ⑧ OBU C3080 avec câble, ⑨ Chiffon de nettoyage, ⑩ Support avec pastilles adhésives

Caractéristiques techniques : A Température, B Tension, C Consommation électrique, D GNSS interne, E GSM interne, F DSRC interne, G Pile, H Classe de protection, I Poids (sans support), J Dimensions (sans support)

Données techniques fournies par :

Siemens AG, RC-DE
Otto-Hahn-Ring 6
81739 Munich
Germany

Avvertenze di sicurezza:



Utilizzo in locali a rischio di esplosione:

È vietato utilizzare l'apparecchiatura nei locali a rischio di esplosione ai sensi della Direttiva 2014/53/UE. In caso di utilizzo in locali a rischio di esplosione, seguire le disposizioni contenute nel manuale di istruzioni.



Pericolo dovuto alla batteria ricaricabile:

Proteggere la batteria ricaricabile dalle sollecitazioni meccaniche (urti, cadute, vibrazioni) e da temperature superiori a 85 °C! Pericolo d'incendio! Ulteriori provvedimenti di protezione e regole di comportamento sono riportati nelle disposizioni contenute nel manuale di istruzioni.



Pericolo dovuto alla scarsa visibilità:

Montare l'OBU sempre sul parabrezza anteriore in modo da non ostacolare la vista del conducente. In caso di dubbi contattare l'Assistenza clienti.



Pericolo durante la marcia:

Non è consentito manovrare l'OBU durante la marcia. Il tasto di navigazione è bloccato per escluderne l'utilizzo durante la marcia.



Avvertenze generali:

Non impiegare per l'OBU oggetti appuntiti o affilati. Per la pulizia non utilizzare in alcun caso sostanze abrasive o solventi, bensì solamente un panno leggermente inumidito. Sostituire immediatamente il cavo di alimentazione se danneggiato: pericolo di cortocircuito!



Avvertenze per il fissaggio:

L'area di fissaggio sul parabrezza anteriore deve essere pulita, asciutta, priva di grasso e di olio. Il supporto deve essere applicato sul parabrezza a temperature superiori a +20 °C. Se necessario portare dapprima il parabrezza e il supporto ad un temperatura idonea. L'adesivo si indurisce completamente a temperature superiori ai +20 °C dopo 72 ore dall'applicazione.

Indicazioni per il montaggio e la messa in funzione:

La Sitraffic Sensus Unit C3080 (OBU) è un'apparecchiatura riutilizzabile facile da installare. La prima messa in funzione si svolge automaticamente.

Altre avvertenze di sicurezza e esaurienti istruzioni per l'uso sono disponibili su www.toll4europe.eu

Servizio clienti:

In caso di domande sulla Sua OBU La preghiamo di rivolgersi al Suo rivenditore.



Non smaltire il prodotto con i rifiuti domestici!

Restituzione vedi su: www.toll4europe.eu

Marcatura CE e dichiarazione di conformità:

L'OBU è conforme ai requisiti delle seguenti direttive:

2014/53/EU	DIRETTIVA 2014/53/UE DEL PARLAMENTO EUROPEO E DEL CONSIGLIO del 16 aprile 2014 concernente l'armonizzazione delle legislazioni degli Stati membri relative alla messa a disposizione sul mercato di apparecchiature radio e che abroga la Direttiva 1999/5/CE
2011/65/EC	DIRETTIVA 2011/65/UE DEL PARLAMENTO EUROPEO E DEL CONSIGLIO dell'8 giugno 2011 sulla restrizione dell'uso di determinate sostanze pericolose nelle apparecchiature elettriche ed elettroniche
2009/750/EG Annex III/2.1.2	DECISIONE DELLA COMMISSIONE del 6 ottobre 2009 sulla definizione del servizio europeo di telepedaggio e dei relativi elementi tecnici, allegato III/2.1.2

È possibile scaricare la Dichiarazione di conformità al sito:

www.siemens.com/mobility-sensusunit-certificates **Sitraffic Sensus Unit C3080**

In questo prodotto viene impiegato un software open source.

Ulteriori informazioni al proposito sono disponibili sul sito:

www.siemens.com/mobility-sensusunit-certificates **License terms**

Spiegazioni:

Lato anteriore: ① Display, ② Spia di stato, ③ Tasto di navigazione con quattro direzioni
Lato posteriore: ④ Vano batteria

Dotazione della fornitura:

⑤ Cartone, ⑥ Inserto, ⑦ Istruzioni di installazione, ⑧ OBU C3080 con cavo, ⑨ Panno di pulizia, ⑩ Supporto con pad adesivi

Dati tecnici:

Ⓐ Temperatura, Ⓑ Tensione, Ⓒ Assorbimento di corrente, Ⓓ GNSS interno, Ⓔ GSM interno, Ⓕ DSRC interno, Ⓖ Batteria, Ⓗ Grado di protezione, Ⓘ Peso (senza supporto), Ⓜ Dimensioni (senza supporto)

Dati tecnici messi a disposizione da:

Siemens AG, RC-DE
Otto-Hahn-Ring 6
81739 Munich
Germany

Consignas de seguridad:**Uso en recintos potencialmente explosivos:**

Conforme a la Directiva UE 2014/53/UE, no está permitido utilizar el aparato en recintos potencialmente explosivos. Si se utiliza en recintos potencialmente explosivos, deberán seguirse las instrucciones del manual del operador.

**Peligro por la batería:**

Proteja la batería de cargas mecánicas (golpes, caídas, vibraciones) o de temperaturas superiores a 85 °C. Peligro de incendio. Encontrará otras medidas de protección y normas de actuación en las instrucciones del manual del operador.

**Riesgo por obstáculo a la visión:**

Monte la OBU siempre en la ventana frontal, de manera que no afecte al campo visual del conductor. En caso de duda, póngase en contacto con el Servicio de atención al cliente.

**Riesgo durante el desplazamiento:**

No está permitido manejar la OBU durante los desplazamientos. La tecla de navegación está bloqueada para excluir cualquier manejo durante el desplazamiento.

**Indicaciones generales:**

No maneje la OBU con objetos punzantes o cortantes. Para la limpieza utilice únicamente un paño ligeramente humedecido; en ningún caso utilice disolventes o detergentes. Si el cable de alimentación está dañado, sustitúyalo inmediatamente; peligro de cortocircuitos.

**Indicaciones sobre fijación:**

La zona de fijación de la ventana frontal debe estar limpia, seca, sin aceite ni grasa. La colocación del soporte en el parabrisas debe realizarse a temperaturas superiores a +20 °C. En caso necesario, coloque primero la luna y el soporte a una temperatura adecuada. Con temperaturas superiores a +20 °C, el adhesivo habrá endurecido completamente 72 horas después de su aplicación.

Indicaciones relativas al montaje y a la puesta en servicio:

La Sitraffic Sensus Unit C3080 (OBU) es un dispositivo reutilizable de sencilla instalación. La primera puesta en servicio se desarrolla de forma automática.

Solicite más indicaciones de seguridad y un detallado manual de instrucciones en: www.toll4europe.eu

Servicio de atención al cliente:

En caso de dudas diríjase al Servicio de atención al cliente: 00800 32682931



¡No deseché este producto, bajo ningún concepto, junto con la basura doméstica! Devolución en: www.toll4europe.eu

Marca CE y Declaración de conformidad:

La OBU se corresponde con las especificaciones de las siguientes directivas:

2014/53/EU	DIRECTIVA 2014/53/UE DEL PARLAMENTO EUROPEO Y DEL CONSEJO de 16 de abril de 2014 sobre la armonización de las leyes de los Estados miembros sobre la puesta a disposición de equipos radioeléctricos en el mercado y por la que se deroga la Directiva 1999/5/CG
2011/65/EC	DIRECTIVA 2011/65/UE DEL PARLAMENTO EUROPEO Y DEL CONSEJO de 8 de junio de 2011 sobre las restricciones a la utilización de determinadas sustancias en aparatos eléctricos y electrónicos
2009/750/EG Anexo III/2.1.2	DECISIÓN DE LA COMISIÓN de 6 de octubre de 2009 sobre la especificación de las características del servicio de telepeaje electrónico europeo y sus componentes técnicos; Anexo III/2.1.2

La Declaración de conformidad puede obtenerse en:

www.siemens.com/mobility-sensusunit-certificates **Sitraffic Sensus Unit C3080**

En este producto se emplea Open Source Software.

Encontrará más información en:

www.siemens.com/mobility-sensusunit-certificates **License terms**

Explicaciones

Parte frontal: ① pantalla, ② indicador de estado, ③ tecla de navegación con cuatro direcciones

Parte posterior: ④ compartimento de pilas

Volumen de suministro:

⑤ caja, ⑥ depósito, ⑦ instrucciones de instalación, ⑧ OBU C3080 con cable, ⑨ paño de limpieza, ⑩ soporte con cintas adhesivas

Datos técnicos:

Ⓐ temperatura, Ⓑ tensión, Ⓒ consumo de corriente, Ⓓ GNSS interno, Ⓔ GSM interno, Ⓕ DSRC interno, Ⓖ batería, Ⓗ grado de protección, Ⓘ peso (sin soporte), Ⓢ dimensiones (sin soporte)

Datos técnicos facilitados por:

Siemens AG, RC-DE
Otto-Hahn-Ring 6
81739 Munich
Germany

Wskazówki dotyczące bezpieczeństwa:

- ⚠️ Użytkowanie w pomieszczeniach zagrożonych wybuchem:**
Zgodnie z Dyrektywą UE numer 2014/53/UE użytkowanie urządzenia w pomieszczeniach zagrożonych wybuchem jest niedozwolone. W przypadku użytkowania w pomieszczeniach zagrożonych wybuchem należy postępować zgodnie z nakazami zawartymi w instrukcji obsługi.
- ⚠️ Zagrożenie ze strony akumulatora:**
Chronić akumulator przed obciążeniami mechanicznymi (uderzenia, upadki, drgania) oraz temperaturami powyżej 85 °C. Niebezpieczeństwo pożaru. Więcej środków ochronnych i zasad postępowania określają nakazy zawarte w instrukcji obsługi.
- ⚠️ Zagrożenie wynikające z ograniczenia widoczności:**
Urządzenie należy montować na przedniej szybie zawsze tak, aby nie ograniczało pola widzenia kierowcy. W razie pytań proszę skontaktowanie się z działem obsługi klienta.
- ⚠️ Niebezpieczeństwo w czasie jazdy:**
Obsługa urządzenia w czasie jazdy jest niedozwolona. Przycisk nawigacji jest zablokowany, aby wykluczyć obsługę w czasie jazdy.
- ⚠️ Informacje ogólne:**
Nie obsługiwać urządzenia przy użyciu ostrych lub ostro zakończonych przedmiotów. Do czyszczenia używać tylko lekko zwilżonej ściereczki, w żadnym wypadku nie używać środków szorujących lub rozpuszczalników. Uszkodzony przewód zasilania energią elektryczną należy natychmiast wymienić – niebezpieczeństwo zwarcia!
- ⚠️ Wskazówki dotyczące zamocowania:**
Miejsce mocowania na przedniej szybie musi być czyste, suche, wolne od oleju i smaru. Uchwyt należy mocować do przedniej szyby w temperaturze powyżej +20 °C. W razie potrzeby należy najpierw ogrzać szybę i uchwyt do odpowiedniej temperatury. Całkowite utwardzenie kleju w temperaturze powyżej +20 °C następuje po 72 godzinach.

Wskazówki dotyczące montażu i uruchomienia:

Sitrafic Sensus Unit C3080 (OBU) to łatwe w instalacji urządzenie pokładowe wielokrotnego użytku. Jego pierwsze uruchomienie następuje automatycznie. Pozostałe informacje dotyczące bezpieczeństwa oraz instrukcja obsługi są dostępne pod adresem: www.toll4europe.eu

Obsługa klienta:

W razie pytań dotyczących urządzenia pokładowego należy się zwrócić do sprzedawcy.



Niniejszego urządzenia nie wolno usuwać wraz z odpadami komunalnymi! Zwrot – patrz: www.toll4europe.eu

Oznaczenie CE i deklaracja zgodności:

Urządzenie OBU spełnia wymagania określone przez następujące dyrektywy:

2014/53/UE	DYREKTYWA 2014/53/UE PARLAMENTU EUROPEJSKIEGO I RADY z dnia 16 kwietnia 2014 roku w sprawie harmonizacji ustawodawstw państw członkowskich dotyczących udostępniania na rynku urządzeń radiowych i uchylająca dyrektywę 1999/5/WE
2011/65/EC	DYREKTYWA 2011/65/UE PARLAMENTU EUROPEJSKIEGO I RADY z dnia 8 czerwca 2011 roku w sprawie ograniczenia stosowania niektórych niebezpiecznych substancji w sprzęcie elektrycznym i elektronicznym
2009/750/EG Annex III/2.1.2	DECYZJA KOMISJI z dnia 6 października 2009 roku w sprawie definicji europejskiej usługi opłaty elektronicznej oraz jej elementów technicznych; załącznik III / 2.1.2

Deklarację zgodności można pobrać pod adresem:

www.siemens.com/mobility-sensusunit-certificates **Sitrafic Sensus Unit C3080**

W tym produkcie używane jest oprogramowanie otwarte (ang. Open Source Software).

Więcej informacji na ten temat znajduje się na stronie internetowej:
www.siemens.com/mobility-sensusunit-certificates **License terms**

Objaśnienia:

Przód: ① Wskaźnik, ② Wskaźnik stanu, ③ Przycisk nawigacji w czterech kierunkach
Tył: ④ Schowek na baterie

Zakres dostawy:

⑤ Karton, ⑥ Wkładka, ⑦ Instrukcja instalacji, ⑧ OBU C3080 z przewodem,
⑨ Ściereczka do czyszczenia, ⑩ Uchwyt z podkładką klejącą

Dane techniczne:

Ⓐ Temperatura, Ⓑ Napięcie, Ⓒ Prąd pobierany, Ⓓ GNSS wewnątrz, Ⓔ GSM wewnątrz, Ⓕ DSRC wewnątrz, Ⓖ Bateria, Ⓗ Stopień ochrony, Ⓘ Masa (bez uchwytu),
⓫ Wymiary (bez uchwytu)

Dane techniczne udostępnione przez:

Siemens AG, RC-DE
Otto-Hahn-Ring 6
81739 Munich
Germany